

N° de Ref. : 264

Clavija AM-TOP

carcasa de una pieza, prensaestopas roscado con estanqueidad, antitracción y protección contra deformaciones del cable

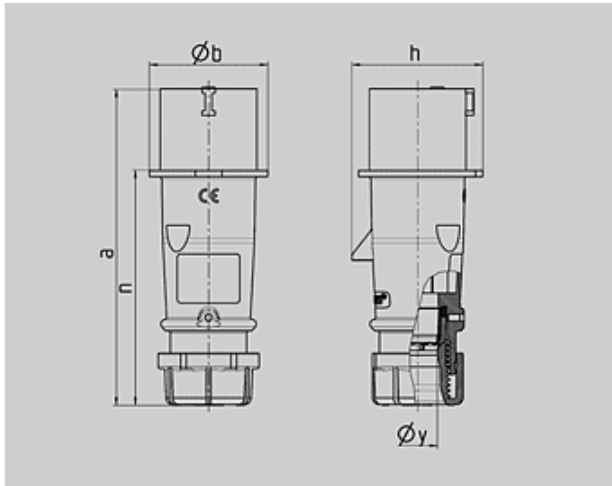

Plano	Amp.	16			32		
		2 MB 217 Polos			3	4	5
Dim. en mm	a	142	147	147	186	186	180
	b	53	59	67	70	70	77
	h	59	69,4	76	81	81	89,5
	n	105,2	110,5	110,5	141	141	135
	y	14,5	16	16	22	22	22
Borna para cond. Transvers. (mm ²) min.-máx.		1	1	1	2,5	2,5	2,5
		-2,5	-2,5	-2,5	-6	-6	-6

 Grupo de artículos : **2141**

voltages : 400V

rated current : 32A

pole : 4 pole







IP protection types : IP44

position of ground contact : 6h

packing unit : 0010

Peso : 222 g

N° DE REF.

V	110V	230V	400V	500V	>50-500V	
Hz	50,60	50,60	50,60	50,60	100-300	300-500
Color código						
Amperios						
16 A	3	247	248	249	2168	2271
	4	250	251	252	253	254
	5	256	257	3	2014	2189
32 A	3	259	260	261	2195	2341
	4	262	263	<u>264</u>	265	266
	5	268	269	4	2015	2244