

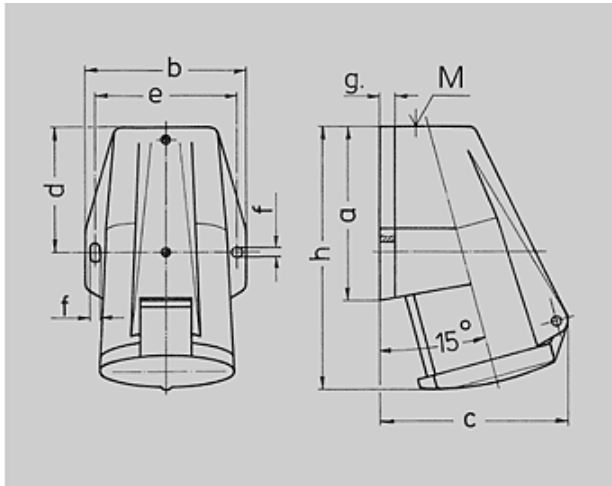

N° de Ref. : 1269

Base

Fijación exterior, entrada de cable superior



Plano	Amp.	16			32		
		Polos			3	4	5
1 MB 205							
Dim. en mm	a	91	91	91	102	102	102
	b	73	79	87	89	89	94
	c	86	93	99	108	108	114
	d	55	55	56,4	62	62	62
	e	62	68	76	77,5	77,5	84
	f	5,3	5,3	5,3	5,3	5,3	5,3
	g.	8	8	9	10	10	10
	h	132	132	132	153	153	153
	M	20	25	25	25	25	32
	Diám. máx. de cable (mm)	13	18	18	18	18	25
Borna para cond. Sección Transvers. (mm ²) min.-máx.	1,5	1,5	1,5	2,5	2,5	2,5	
	-4	-4	-4	-10	-10	-10	

 Grupo de artículos : **1037**

voltages : 500V

rated current : 16A

pole : 4 pole







IP protection types : IP44

position of ground contact : 7h

packing unit : 0010

Peso : 220 g

N° DE REF.

V	110V	230V	400V	500V	>50-500V	
Hz	50,60	50,60	50,60	50,60	100-300	300-500
Color código						
Amperios						
16 A	3	1177	1178			
	4		1267	1268	1269	
32 A	3	1368	1369			
	4		1372	1373	1374	